

Ron's Tissue DNA Mini Kit

Kit for the isolation of genomic DNA from human and animal tissue incl. mouse tail and preserved tissue

Research Use Only (RUO)

Content

1. Introduction	2
2. Content of the Kit.....	2
3. Storage Conditions and Stability.....	3
4. Quality Control	3
5. Safety Information	3
6. Protocol.....	5
7. Flowchart of Extraction.....	8
8. Troubleshooting	10
9. Warranty and Guarantee of Products	10
10. Limitations of Product Use	10

Ron's Tissue DNA Mini Kit	Ref. No: 803496 (50 preps)
	Ref. No: 803496L (5 x 50 preps)
Valid from:	September 2018

BIORON GmbH - Rheinhorststr.18 - 67071 Ludwigshafen (Germany)

Phone +49 621 5720 915 - Fax +49 621 5720 916

info@bioron.net www.bioron.net

Ron's Tissue DNA Mini Kit

1. Introduction

The **Ron's Tissue DNA Mini kit** is designed for quick preparation of pure DNA. The kit contains spin columns, buffers and reagents necessary for cell lysis, DNA binding, washing and elution of DNA into small volume. Each kit contains a manual with detailed protocols of DNA extraction and purification from tissue of animal/human origin.

The Ron's Tissue DNA Mini kit presents remarkable features of timesaving, easy, prompt and high yield DNA purification. The procedure is based on optimized buffers and the use of our specially designed **Ron's spin columns**. The advanced buffer system is optimized for efficient recovery of DNA and removal of contaminants. DNA is adsorbed to the uniquely designed Ron's spin membrane and all impurities are efficiently removed by washing. The pure DNA is directly eluted in a special buffer.

Various samples have been evaluated with this kit (e.g. snails, deep sea mussels, clams, worms) and mammalian tissue (muscle, brain, heart, liver, kidney and lung from rat, bovine ear cartilage and mouse tails). The material can be fresh or frozen, but also alcohol-preserved or even paraffin-embedded.

2. Content of the Kit

Ref No	S803496 10 preps (sample size)	803496 50 preps	803496L 5 x 50 preps	Storage
Mini spin columns	10	50	5 x 50	RT
Collection tubes 2.0 ml	10	50	5 x 50	RT
Lysis Buffer TCBL-1 ^a	11 ml	11 ml	5 x 11 ml	RT
Binding Buffer TGP-2	11 ml	11 ml	5 x 11 ml	RT
Wash Buffer TGI-3 concentrate ^b	18 ml	18 ml	5 x 18 ml	RT
Wash Buffer TE-4 concentrate ^c	5.1 ml	5.1 ml	5 x 5.1 ml	RT
Elution Buffer EL-3	11 ml	11 ml	5 x 11 ml	RT
Proteinase K (20 mg/ml)	1.1 ml	1.1 ml	5 x 1.1 ml	-20°C
Manual	1	1	1	-

a. Precipitates in Lysis Buffer TCBL-1 should be dissolved by warming up to 55 °C.

b/ c Note before starting:

Preparation of Wash buffer TGI-3 and Wash Buffer TE-4 (see page 4)

BIORON GmbH - Rheinhorststr.18 - 67071 Ludwigshafen (Germany)

Phone +49 621 5720 915 - Fax +49 621 5720 916

info@bioron.net www.bioron.net

3. Storage Conditions and Stability

Spin columns of the kit are packed in closed bags and show full performance in this condition at room temperature (18 - 25 °C) for at least 2 years. Proteinase K is delivered as solution and should be stored upon arrival at -20 °C. Store buffers at room temperature (18-25 °C).





Guarantee for full performance of the kit as specified in this manual is only valid if storage conditions are followed. Please take care that columns, once opened, should be used instantly.

4. Quality Control

The performance of the **Ron's Tissue DNA Mini Kit** is monitored routinely on a lot-to-lot basis.

5. Safety Information

The following components of **Ron's Tissue DNA Mini Kit** contain hazardous contents. It is strongly recommended to wear a lab coat, disposable gloves and protective goggles when working with chemicals. More detailed information is available in the material safety data sheets, which can be requested from the manufacturer. There is no need of labeling harmful features with H & P phrases upon packing sizes of 125 ml or 125 g.

Component	Hazard content	GHS symbol		Hazard phrases	Precaution phrases
Lysis Buffer TCB-1	SDS Sodium dodecyl sulphate (0.1-1%)		Warning	302, 319	280, 301+312 305+351+338, 330, 337+313
Binding Buffer TGP-2	Guanidine hydrochloride 36-50%		Warning	302, 319	280, 301+312 305+351+338, 330, 337+313
Wash Buffer TGI-3	Guanidine hydrochloride 36-50%		Warning	302, 319	280, 301+312 305+351+338, 330, 337+313
Proteinase K Solution	Proteinase K 20 mg/ml	 	Warning Danger	315, 319, 334, 335	261,280, 302+352, 304+340, 305+351+338, 312,332+313, 337+313, 342+311, 403+233

Ron's Tissue DNA Mini Kit

Hazard phrases	
H302	Harmful if swallowed
H315	Cases skin irritation
H319	Causes serious eye irritation
H334	May cause allergy asthma symptoms or breathing difficulties if inhaled
H335	May cause respiratory irritation

Precaution phrases	
P280	Wear protective gloves / eye protection
P301+312	If swallowed: call a poison center/doctor/ .../ if you well unwell
P302+352	If on skin: wash with plenty of water
P304+340	If inhaled: go to fresh air and keep at rest in a position comfortable for breathing
P305+351+338	If in eyes: rinse cautiously with clean water for several minutes. Remove contact lenses. Continue rinsing
P312	Call a poison center/doctor/.../ if you feel unwell
P330	Rinse mouth
P332+313	If skin irritation occurs: get medical advice/ attention
P337+313	If eye irritation persists: get medical advice/attention
P342+311	If experiencing respiratory symptoms: call a poison center/ doctor
P403+233	Store in a well ventilated place. Keep container tightly closed

BIORON GmbH - Rheinhorststr.18 - 67071 Ludwigshafen (Germany)

Phone +49 621 5720 915 - Fax +49 621 5720 916

info@bioron.net www.bioron.net

Ron's Tissue DNA Mini Kit

6. Protocol

Additional Material Required:

- 96-100 % ethanol
- 100 % isopropanol
- Incubator/ heat shaker or water bath
- Microcentrifuge
- Receiver tubes (1.5 ml)

Before starting:

Wash Buffer TGI-3 and Wash Buffer TE-4 are concentrates. Before using for the first time, add the appropriate amount of isopropanol (Wash Buffer TGI-3) and ethanol (Wash Buffer TE-4) as indicated on the bottle and in the table below:

Add the appropriate amount of alcohol and mix well:

Ref. No.	S803496 10 preps	803496 50 preps
Wash Buffer TGI-3 concentrate	Add 7.6 ml isopropanol to 18 ml	Add 7.6 ml isopropanol to 18 ml
Wash Buffer TE-4 concentrate	Add 21 ml ethanol to 5.1 ml	Add 21 ml ethanol to 5.1 ml

Required incubators /water baths

Heat an incubator up to 55 °C (see step 1 in protocol) and another to 70 °C (see step 3). Heat Elution Buffer EL-3 up to 70 °C for elution (see step 12).

Ron's Tissue DNA Mini Kit

6a. Sample preparation

To avoid DNA degradation, fresh tissue should be kept chilled while cut into small pieces or homogenized with a blender. Grinding of tissue frozen under liquid nitrogen is an alternative method for homogenization. Small pieces of tissue incl. mouse tails can be used directly for DNA extraction. Material should be processed immediately for DNA extraction.

Fresh tissue: For homogenization, cut up to **200 mg fresh tissue** or up to **50 mg brain** into small pieces and homogenize with a blender. Take care to keep material chilled during the procedure or freeze immediately at -20 °C to avoid DNA degradation.

Preserved tissue: Cut **50 mg alcohol-preserved tissue** into small pieces and extract DNA as below. Highest yields of paraffin-embedded tissues are obtained, when the sample is cut with a microtome to up to 10 µm thickness. Alternatively use up to 50 mg material and slice.

Mouse tail: Up to **1 cm mouse tail** can be used. Transfer homogenized or cut material in a sterile 1.5 ml reaction tube (not provided).

Ron's Tissue DNA Mini Kit

6b. Protocol

1. Add **200 µl Lysis Buffer TCBL-1 + 10 µl Proteinase K Solution** (20mg/ml) to the sample. Vortex thoroughly at maximum speed for 1 minute.
2. Incubate the tube at 55 °C until complete digestion of tissue in heat shaker (1 hour up to overnight).
3. Add **200 µl Binding Buffer TGP-2** to lysate and vortex for 10 seconds.
4. Incubate the solution at 70°C for 10 minutes.
5. Centrifuge the tube at 13000 rpm (approx. 10000 g) for 5 minutes and transfer the DNA-containing supernatant in a new tube (removal of debris by centrifugation).
6. Add **200 µl ethanol** to DNA solution and vortex for 10 seconds.
7. Place a spin column in a provided 2 ml collection tube.
8. Apply the **600 µl liquid sample** to the column and centrifuge the tube at 10000 rpm (approx. 7400 g) for 1 minute.
9. Discard flow through. Place the column back into the same tube. Collection tubes are re-used to reduce plastic waste.
10. Add **500 µl Wash Buffer TGI-3** (add isopropanol before use, as indicated on the bottle) to the column and centrifuge at 10000 rpm (approx. 7400 g) for 1 minute.
11. Discard flow through. Place the column back into the same tube.
12. Add **500 µl Wash Buffer TE-4** (add ethanol before use as indicated on the bottle) to the column and centrifuge at 10000 rpm (approx. 7400 g) for 2 minutes to remove complete wash buffer.
13. Place the column in a 1.5 ml receiver tube (not provided) and heat the column at 70°C for 2 - 5 minutes to remove the rest of alcohols. Add **50 - 100 µl Elution Buffer EL-3** (heated up to 70°C) to the column and incubate for 2 minutes at room temperature.
14. Centrifuge at 10000 rpm (approx. 7400 g) for 1 minute and collect the eluate and proceed with down-stream processing (gel electrophoresis, PCR etc.)

Note: it is very important to remove rests of alcohol. Residue of wash buffer can decrease DNA recovery.

7. Flowchart of Extraction

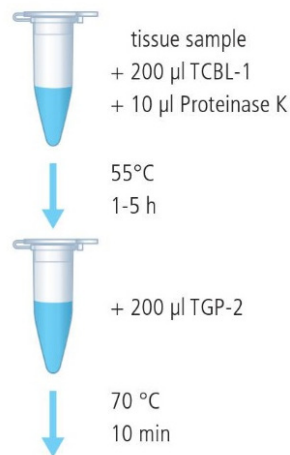

Step 1: Dissociation and Lysis



Step 2: Removal of debris



Step 3: Binding DNA on column

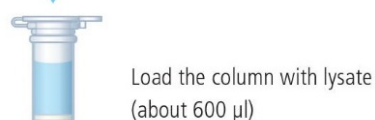

Ron's Tissue DNA Mini Kit

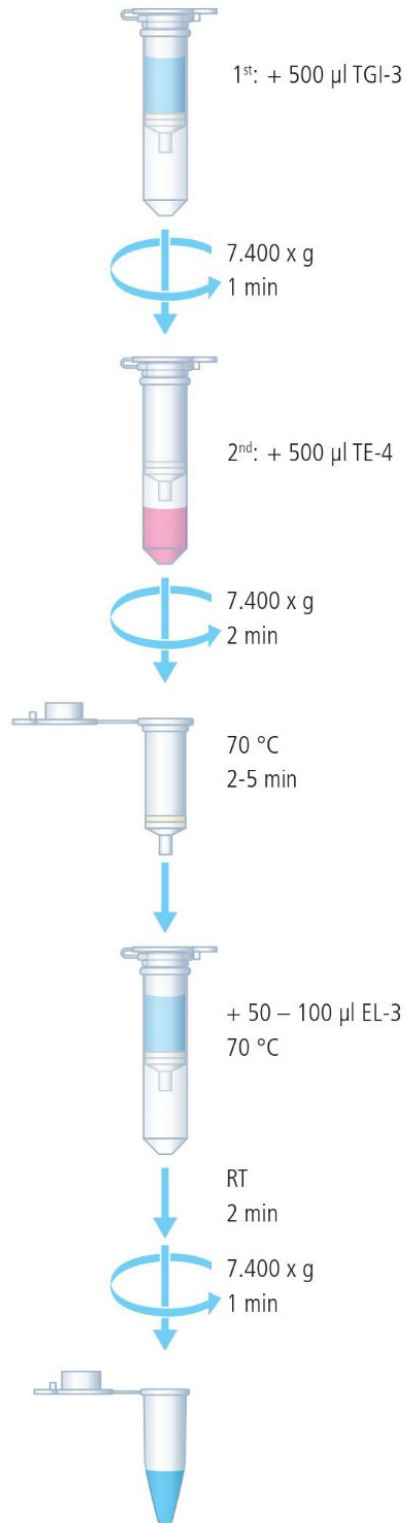

BIORON GmbH - Rheinhorststr.18 - 67071 Ludwigshafen (Germany)

Phone +49 621 5720 915 - Fax +49 621 5720 916

info@bion.net www.bion.net

8. Troubleshooting

This guide can help solve problems that may arise. BIORON GmbH welcomes comments and suggestions for improvement and supplement of our protocols or any hints on other molecular biology applications. The BIORON team is always pleased to answer any of your questions about our products.

Observation	Possible cause	Comments/suggestions
Low or no DNA yield	Inefficient lysis of sample Lysis Buffer TCBL-1 not added Binding Buffer TGP-2 not added	Proteinase K added to Lysis Buffer? Stored at -20°C? Ensure that Lysis Buffer TCBL-1 has been added and mixed with the lysate. Ensure that Binding Buffer TGP-2 has been added to and mixed with the lysate
DNA "smear"	Nuclease activity/contamination	Upon disintegration of samples, cellular nucleases are released and may degrade genomic DNA. Whenever possible, fresh samples should be used and processed immediately. Use only sterilized glass and plastic ware in order to avoid nuclease contamination.
Low DNA performance	Salt in eluate	Make sure that you followed all washing steps of the procedure.

Technical Support

If you have questions or suggestions for improvement of this kit, please send us an email: info@bioron.net

9. Warranty and Guarantee of Products

The manufacturer guarantees the performance of its Ron's Tissue DNA Mini Kit in the manner described in this handbook. It is up to the user to determine the suitability of Ron's Tissue DNA Mini Kit for its particular use. In case a product fails to perform due to any reason except misuse, the manufacturer will replace it without further charge or refund the purchase price. We reserve the right to change, alter or modify our Ron's Tissue DNA Mini Kit to enhance its performance and design. The manufacturer's terms and conditions are available on request.

10. Limitations of Product Use

The use of all products of **Ron's Purification Kits** is strictly limited to research purposes. They are not to be applied for any diagnostic use, including human or drug purposes.